

Fiber Optic Connections for MOST Networks



Fiber Optic Connections for MOST Networks



TE Connectivity (TE) began its commitment to fiber optic technology in 1975. Since then, TE continues to provide solutions that go from the circuit board to the end-user.

TE is a market leader for design and process development of in vehicle optical communication solutions. We offer a product range of physical layer components for devices communicating on Media Oriented System Transport (MOST), network.

TE's fiber optics provide a complete range of components for MOST 25 and MOST 150 connectors including PCB and harness connectors, cable assemblies and processing equipment. The development of such components was backed by TE's know how of optics and collaboration with Tier 1 and Tier 2 customers.

TE developed an optical high speed multimedia network based on 1000µm Polymer Optical Fiber (POF) supporting data speed of 25 Mbps and 150 Mbps.



Benefits and Key Features







- No EMI/EMC interferences at the cable.
- Light weight of POF.
- Application is based on optical ring structure with various nodes and hence less cabling is required.
- Reflow and wave soldering versions available for headers.
- Pigtail versions have the flexibility to be soldered at the header and at the connector independently. This flexibility ensures that the plastic of fiber is not damaged by solder heat.
- Wide range of connectors and headers available.
- Cost efficient-design and process perfectly aligned for automotive market needs.
- Modular and scalable solution that fits to automotive connectivity building blocks and OEMs.
- Cable harness product range along with repair tool set available.

Applications



- Head Unit
- DVD Player
- Instrument Cluster
- Amplifier
- TV Tuner
- Rear Seat Entertainment

Market Compatibility

- MOST cooperation compliant
- 1000µm Polymer Optical Fiber (POF)
- Available for MOST 25 and MOST 150 protocol
- ISO standard (preliminary work item)

MOST Micro-Pigtails	Description	TE PN
MOST 25		
	90° semi-shielded MOST 25	0-2141577-1 2-2141577-1
	90° fully-shielded MOST 25	1-2141103-1 1-2112079-1
	180° MOST 25	1-2141352-1 1-2141352-2
MOST 150		
	90° fully-shielded MOST 150	1-1823724-1 ^{*)} 1-2112180-3 ^{*)} 1-2112181-3 ^{*)} 1-2286542-1 ^{*)}
	180° MOST 150	1-2208264-3 in combination with 1-2208265-1
		

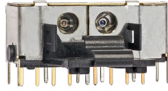
^{*)} coming soon

MOST 25 Flexible Pigtails	Description	TE PN
	2 piece flexible pigtail POF FOT	1-2208204-1
In combination with cable assembly A/B		
	A 2 Position Cable Assembly	1-2208334-1 (compatible to the following MOST interfaces: 2+0, 2+4, 2+12, 2+20)
	B 4 Position Cable Assembly	1-2208207-1 (compatible to MOST interface 4+40)

Typical components in MOST Micro-Pigtail

Micro-Pigtail MOST 150 with glass fiber

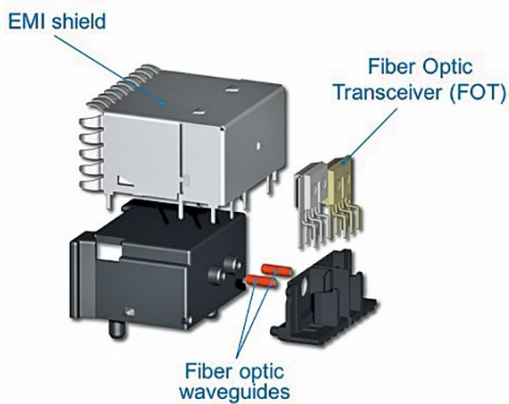

Typical components in MOST pigtail

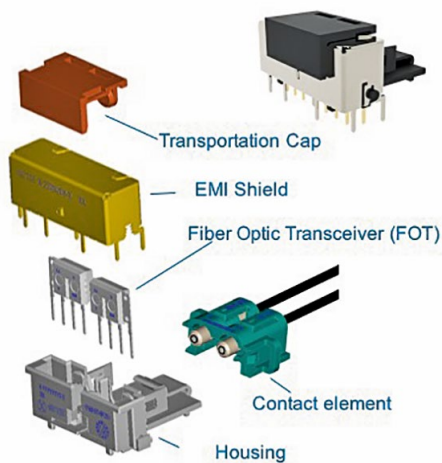

Volumes of all PNs are subjected to availability and confirmation from Product Engineering

For further information please contact :

Archita Ravindra
Product Manager Infotainment
E-mail: archita.ravindra@te.com

Robert Wuerker
Product Engineer Infotainment
E-mail: rwuerker@te.com

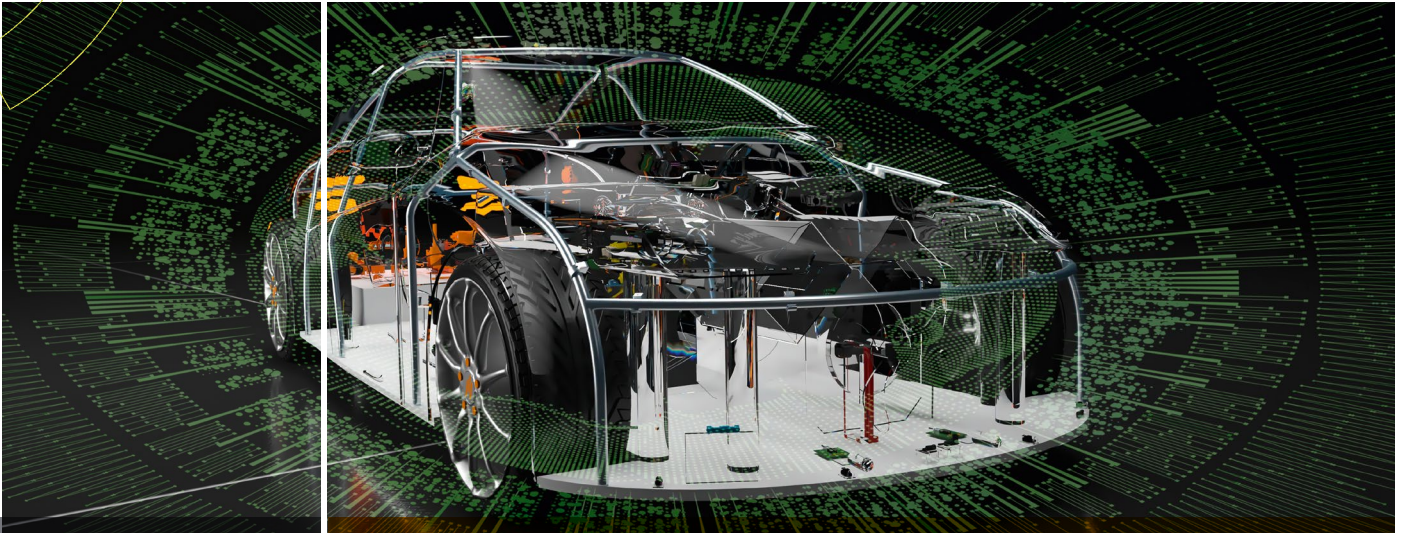

Fiber Optic Connections
for MOST Networks
ONLINE

TE Connectivity Germany GmbH

Ampèrestrasse 12-14
64625 Bensheim | Germany

Product Information Center:
+49 (0)6251 133-1999

www.TE.com

© 2018 TE Connectivity
All rights reserved.

TE, TE Connectivity, and TE connectivity (logo) are trademarks.
MOST is a trademark.

TE Connectivity's only obligations are those stated in TE's General Terms and Conditions of Business (www.te.com/aboutus/tandc.asp). TE expressly disclaims any implied warranty regarding the information contained herein, including, but not limited to, the implied warranties of merchantability or fitness for a particular purpose.

1-1773944-4 | Published 02-2018 | PoD • RRD